

BREBASE Bollard Retrofit Base Kit

The BBASE Bollard Retrofit Base Kit allows installation of new bollards to most existing bolt patterns without removal of existing bolts. Fits all LEPG bollards, both round and square.



Anchor Bolt Retrofit Adapter Plate –

Fits most existing 3-Bolt or 4-Bolt Patterns



Bollard Mounting Cover Plate –

Allows mounting of Bollard using the bollard cast aluminum base plate



Allows for retrofit of ALL Jemm Bollards to most EXISTING anchor bolt patterns.

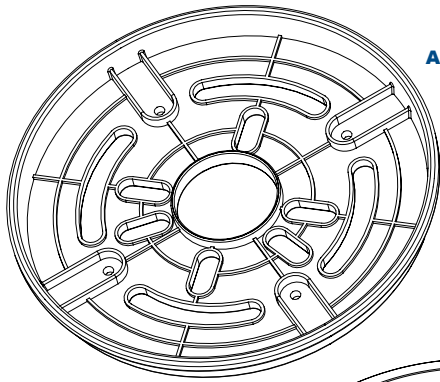

Anchor Bolt Retrofit Adapter Plate –

Mounts to existing anchor bolts

Mounts to Bollard – using Bollard base cast aluminum base plate (Hardware Included)

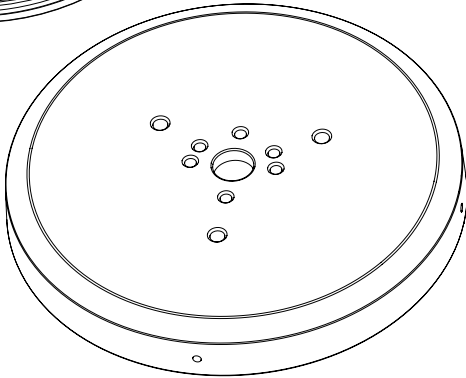

Bollard Mounting Cover Plate –

Mounts to Anchor Bolt Adapter Plate

ALL Round JEMM Bollards



ALL Square JEMM Bollards



See Pages 2 and 3 for Specifications, Installation Guide, and Mounting Details.

Order Information Example:

BREBASEZ

Model	Color
B BASE=Bollard Retrofit Base Kit	B =Black Z =Bronze C =Custom (Consult Factory)

Project Information:

Project Name: _____

Fixture Type: _____

Complete Catalog #: _____

Date: _____

Comments: _____

BBASE Bollard Retrofit Base Kit

Bollard Retrofit Base Kit includes:

Heavy duty die cast aluminum Anchor Bolt Retrofit Adaptor Plate

- Includes slots for existing anchor bolt mounting, 3@120°, 4@90° or 2@180° (3.5" to 5" diameter bolt circle). Slots can accommodate ¼" to ¾" diameter anchor bolts.
- Includes large diameter slots for installing field drilled anchors (not included) in the event that the existing anchor bolt pattern does not fit slots, or anchor bolts are damaged or unusable.
- Includes 4 Stainless Steel leveling bolts with two leveling bubbles at 90° to level base prior to mounting new bollard.
- Includes Center conduit entrance hole designed to accommodate two ¾" PVC conduits.

Heavy duty die cast aluminum Bollard Mounting Cover Plate

- Includes threaded holes in patterns to match ALL JEMM bollard base mounting plates.
- Stainless Steel bolts for mounting bollard base plate.
- 4 Stainless Steel set screws at 90° for securing the cover plate to the adaptor plate. Cover plate can be rotated 360°.

Powdercoat finish over chromate conversion coating in Black or Bronze standard to match JEMM Bollards.

Anchor Bolt Retrofit Adapter Plate

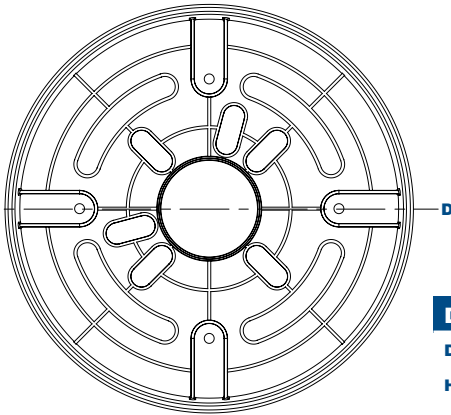

Dimensions

Diameter (D) 10¾" (271mm)

Height (A) 1" (26mm)



Bollard Mounting Cover Plate

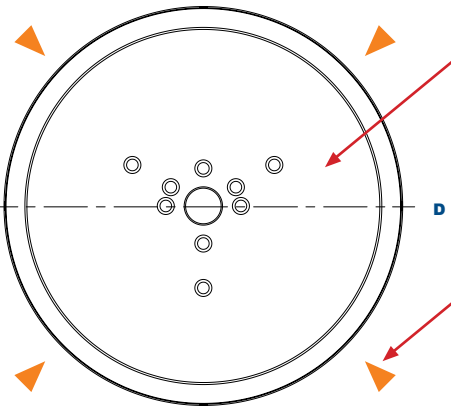

Plate has threaded holes in patterns for each LEPG bollard size. Mounting bolts are included. Bollard base mounts to plate.

Plate includes 4 set screws on sides at 90 degrees for locking base cover to mounting plate. Fully rotatable.

Dimensions

Diameter (D) 11½" (292mm)

Height (A) 1½" (38mm)

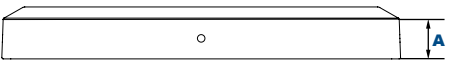

Anchor Bolt Retrofit Adapter Plate Bolt Circles for use with existing anchor bolts.

Conduit Entrance Area Accommodates Two ¾" Stub-Ups.

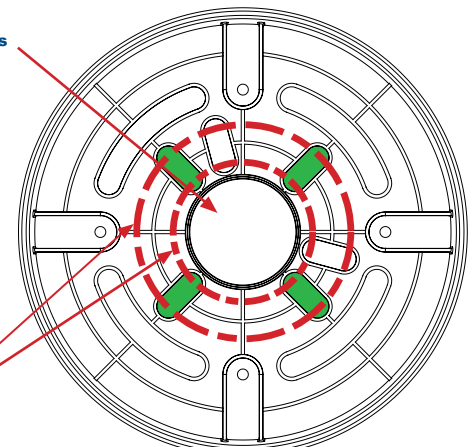

Fits bolt circles from 3.5" to 5"

For use with 4 bolts @ 90° or 2 bolts @ 180°

Anchor Bolt Retrofit Adapter Plate allows for mounting with field installed drilled anchors

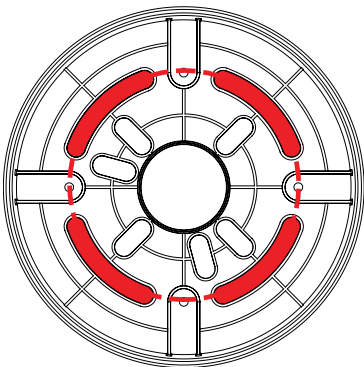

6.5" bolt circle for Drilled Anchors. Used when existing anchor bolts do not fit 4-bolt or 3-bolt slots or are damaged. These must be cut off and new drilled anchors installed.

Anchor Bolt Retrofit Adapter Plate Includes 4 leveling bolts and levels

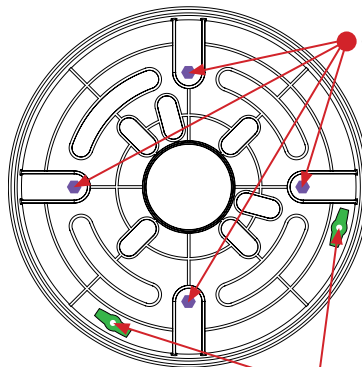

4 Leveling Bolts

Leveling Bubbles

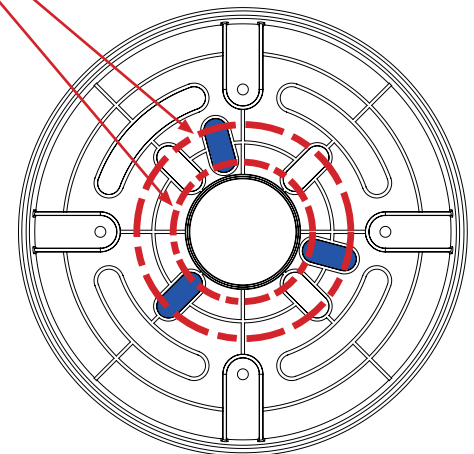

For use with 3 bolts @ 120°

BBASE Bollard Retrofit Base Kit

BBASE Template:

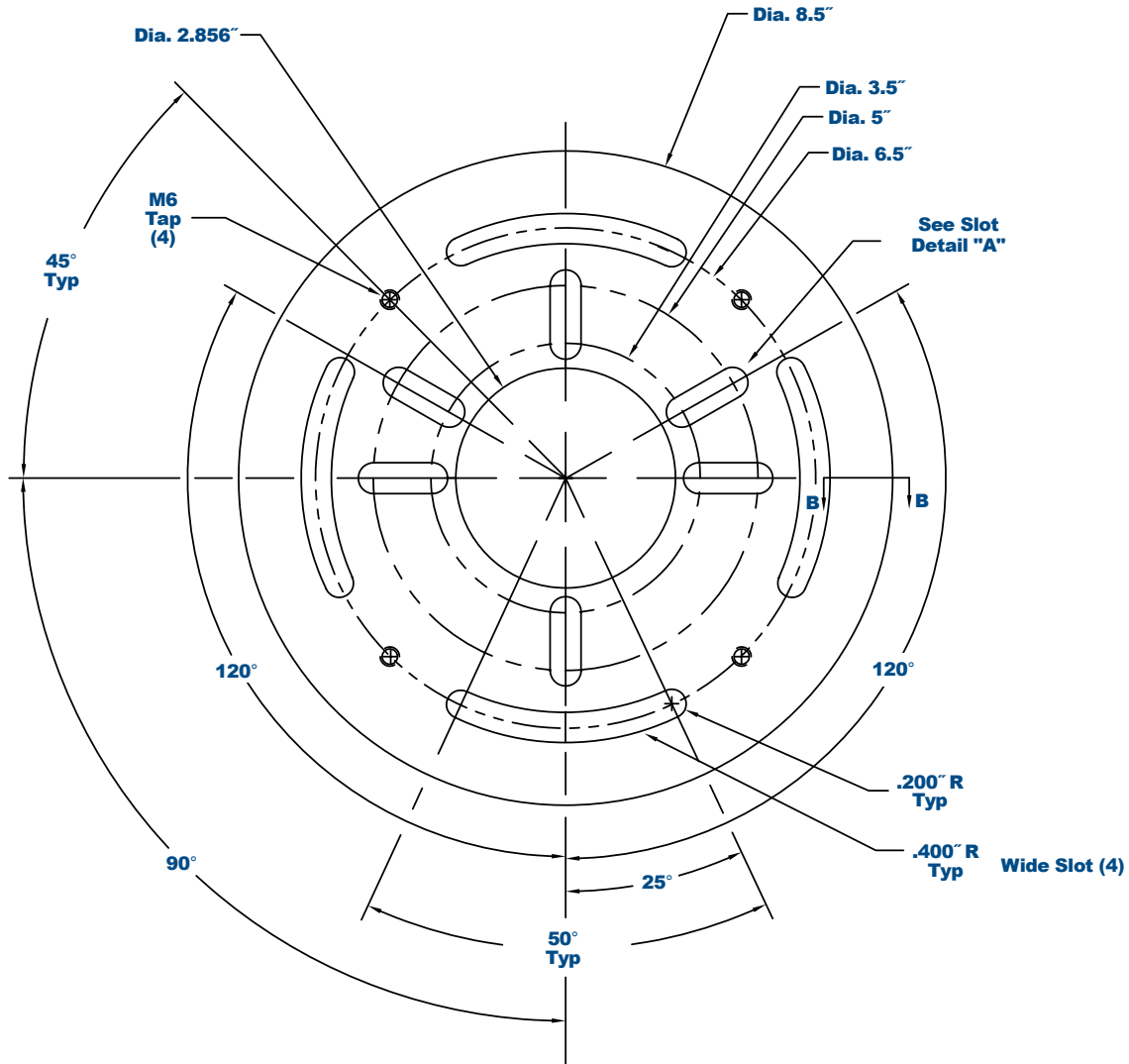

Not to Scale

Slot Detail "A" (6)
Slots Total
Not to Scale

